

SliderNext glas-skydedøre

Monteringsvejledning

Før du kan få glæde af glasskydedørene, skal de monteres forsvarligt. I denne manual får du vejledning i, hvordan du monterer dine glasskydedøre korrekt. Vi anbefaler, at hele manualen læses igennem, før montagen påbegyndes. Sørg også for at overholde de gældende sikkerhedsforskrifter, både for din egen sikkerheds skyld og af hensyn til sikkerheden af de færdigmonterede glasskydedøre.



Håndværktøj og udstyr



Der anbefales 2 personer til montagen:



5m

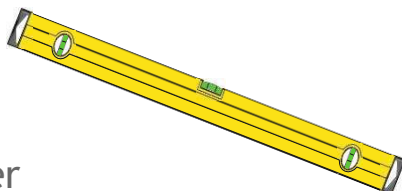

Ø5/Ø8/Ø12/Ø18

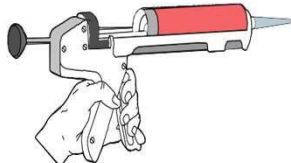
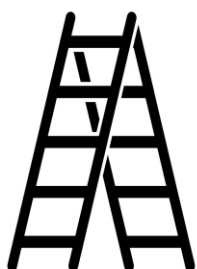
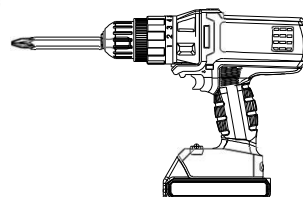
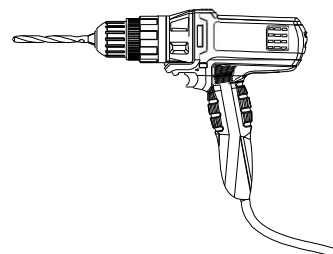

Læs sikkerhedsforanstaltningerne og vejledninger igennem inden montage.

For korrekt montage skal medfølgende retningslinjer overholdes. Garantien bortfalder, hvis skydeglas ikke samles og monteres i henhold til retningslinjerne.

- **Read these instructions carefully before installation.**
- **For correct installation, the following preconditions must be observed.**



Brug tilpassede værnemidler

All Glass System ESG10

SliderNext fås som 3-4 og 5 spor system.
Dette system er ALL-glass med flad bundprofil

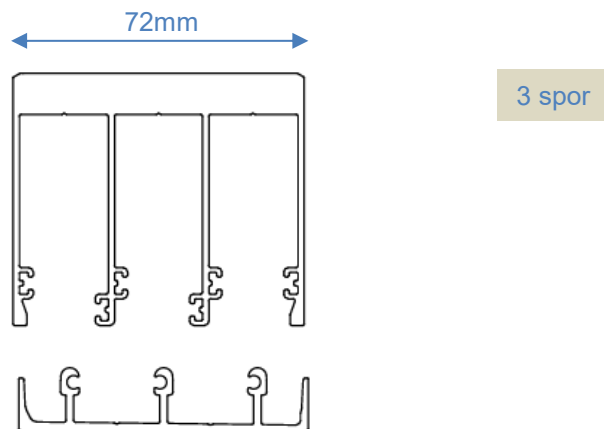
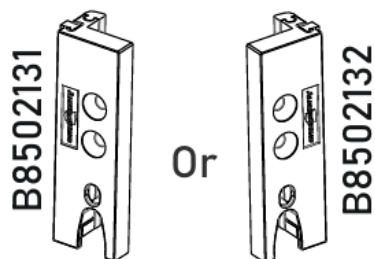
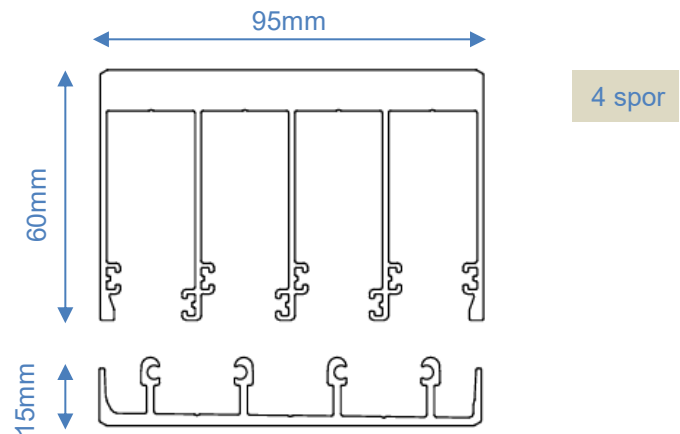
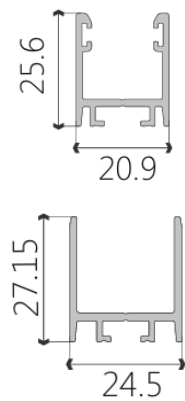
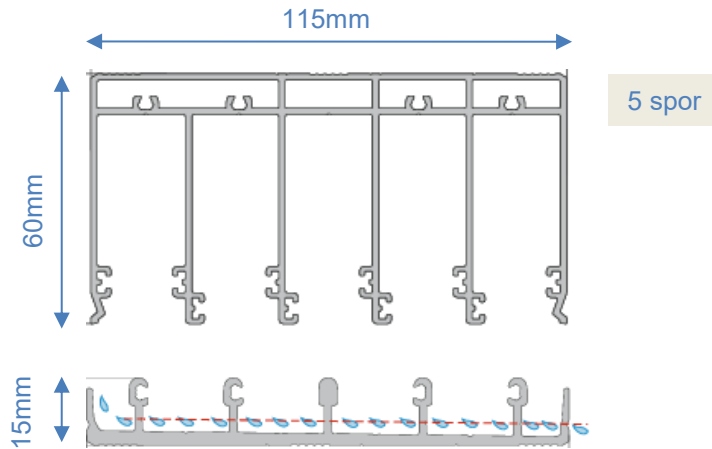
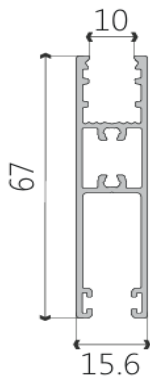

All Glass System ESG10

SliderNext fås som 3-4 og 5 spor system.
Dette system er ALL-glass med flad bundprofil

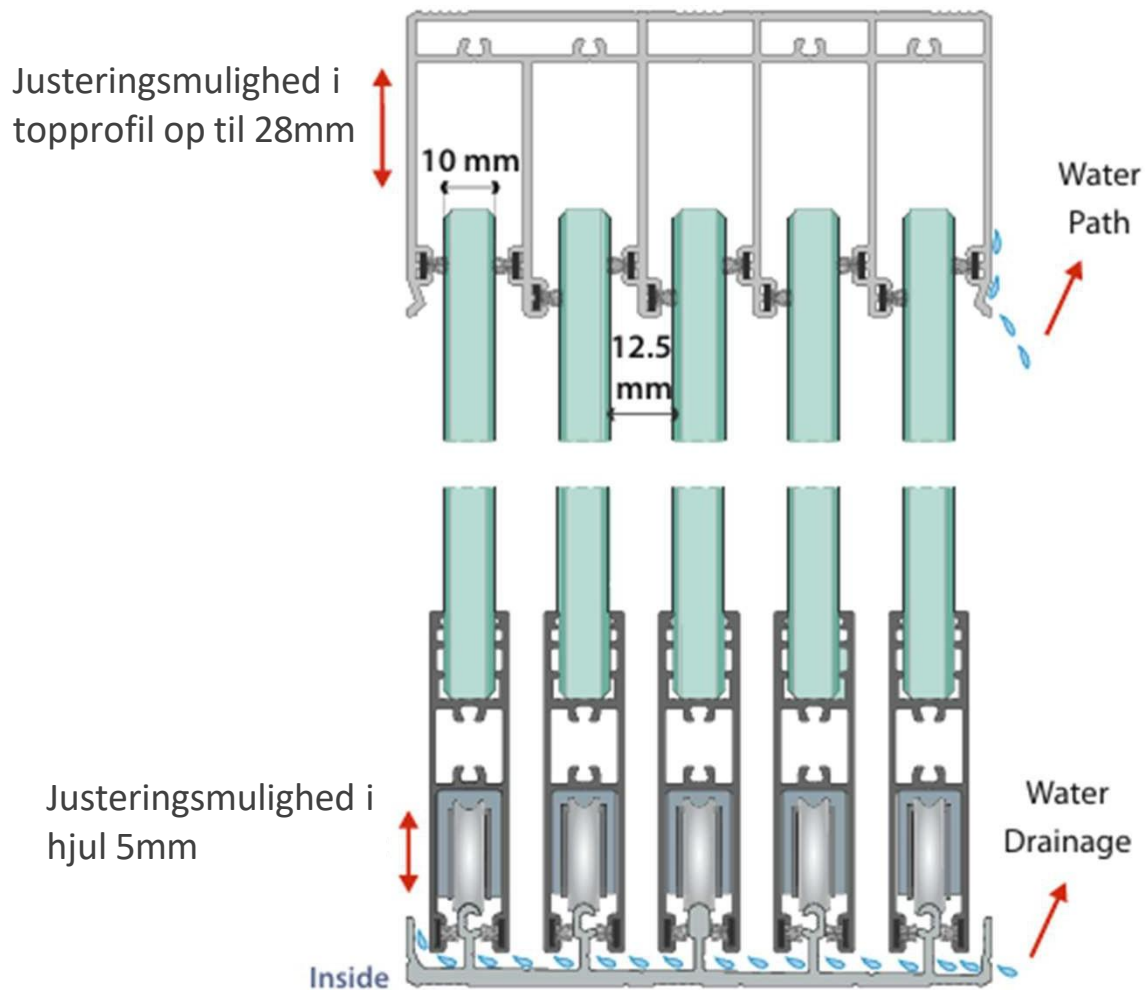

1

Opmåling

Når du skal lave en opmåling til døre, er det vigtigt at kende forskel på hulmål og karmmål.

VIGTIGT! Du skal indtaste karmmål på skydedørens bredde og højde. Du skal selv trække fra hvis der skal være luft omkring døren ud til stolpe eller væg.

Vi anbefaler at du trækker mindst 5 mm fra i hver side, så du er sikker på at dit skydedørsparti kan komme ind i hullet selv om der skulle være lidt skævheder i hullet.

Eksemplar: stram hulmål = 3200 x 2000mm (LxH) **træk 5mm** fra hulmål (3200-5=3195 og 2000-5=1995)

Bestillingsmål (Karmmål) 3195 x 1995mm

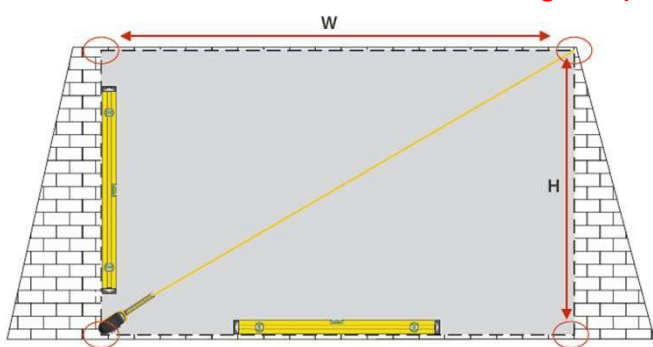

Husk at trække fra hulmål mindst 5 mm fra i hver side.

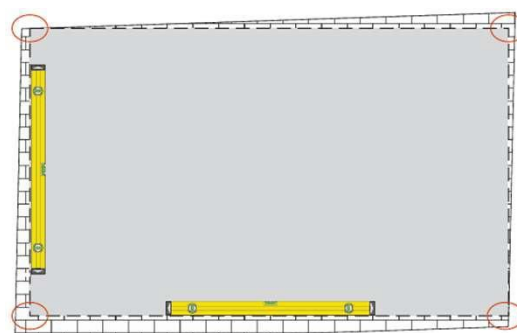

Husk at kontrollere for evt. skævheder i bund og top og lod i siderne.

Angiv ved bestilling hvordan du ønsker dørene er placeret i sporene

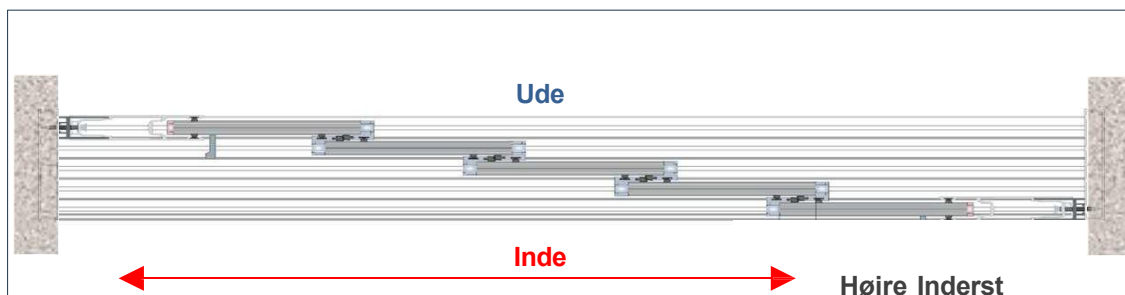
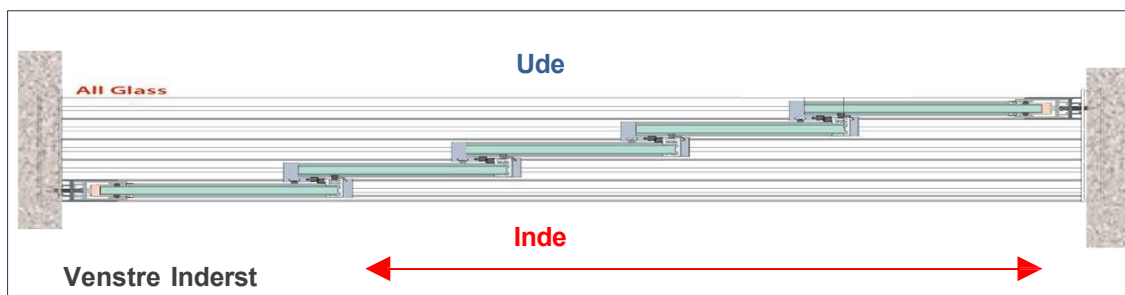

Alle skydedøre leveres med monteret beslag men der er mulighed for at få modsatrettede beslag til udskiftning, hvilket betyder man regulerer hvordan dørene er placeret i sporene under montagen. Derved kan man selv bestemme dørpartiet som Udad/Indad spejlvendte modeller.

2

Størrelser

Maksimal mulige størrelse på enkelte glasdøre iht. systemets begrænsninger. Profilshop har ret til at regulere størrelser mht. produktets brugbarhed.

Dimension Tables

Slider Next-10

width (cm) height (cm) *	80	90	100	110	120	130	140	150	160	170
80	Allowed	Allowed	Allowed	Allowed	Allowed	Allowed	Allowed	Allowed	Allowed	Allowed
90	Allowed	Allowed	Allowed	Allowed	Allowed	Allowed	Allowed	Allowed	Allowed	Allowed
100	Allowed	Allowed	Allowed	Allowed	Allowed	Allowed	Allowed	Allowed	Allowed	Allowed
110	Allowed	Allowed	Allowed	Allowed	Allowed	Allowed	Allowed	Allowed	Allowed	Allowed
120	Allowed	Allowed	Allowed	Allowed	Allowed	Allowed	Allowed	Allowed	Allowed	Allowed
130	Allowed	Allowed	Allowed	Allowed	Allowed	Allowed	Allowed	Allowed	Allowed	Allowed
140	Allowed	Allowed	Allowed	Allowed	Allowed	Allowed	Allowed	Allowed	Allowed	Allowed
150	Allowed	Allowed	Allowed	Allowed	Allowed	Allowed	Allowed	Allowed	Allowed	Allowed
160	Allowed	Allowed	Allowed	Allowed	Allowed	Allowed	Allowed	Allowed	Allowed	Allowed
170	Allowed	Allowed	Allowed	Allowed	Allowed	Allowed	Allowed	Allowed	Allowed	Allowed
180	Allowed	Allowed	Allowed	Allowed	Allowed	Allowed	Allowed	Allowed	Allowed	Allowed
190	Allowed	Allowed	Allowed	Allowed	Allowed	Allowed	Allowed	Allowed	Allowed	Allowed
200	Allowed	Allowed	Allowed	Allowed	Allowed	Allowed	Allowed	Allowed	Not allowed	Not allowed
210	Allowed	Allowed	Allowed	Allowed	Allowed	Allowed	Allowed	Allowed	Not allowed	Not allowed
220	Allowed	Allowed	Allowed	Allowed	Allowed	Allowed	Allowed	Allowed	Not allowed	Not allowed
230	Allowed	Allowed	Allowed	Allowed	Allowed	Allowed	Allowed	Allowed	Not allowed	Not allowed
240	Allowed	Allowed	Allowed	Allowed	Allowed	Allowed	Allowed	Allowed	Not allowed	Not allowed
250	Allowed	Allowed	Allowed	Allowed	Allowed	Allowed	Allowed	Allowed	Not allowed	Not allowed
260	Allowed	Allowed	Allowed	Allowed	Allowed	Allowed	Allowed	Allowed	Not allowed	Not allowed
270	Allowed	Allowed	Allowed	Allowed	Allowed	Allowed	Allowed	Allowed	Not allowed	Not allowed
280	Allowed	Allowed	Allowed	Allowed	Allowed	Allowed	Allowed	Allowed	Not allowed	Not allowed
290	Allowed	Allowed	Allowed	Allowed	Allowed	Allowed	Allowed	Allowed	Not allowed	Not allowed
300	Allowed	Allowed	Allowed	Allowed	Allowed	Allowed	Allowed	Allowed	Not allowed	Not allowed
310	Allowed	Allowed	Allowed	Allowed	Allowed	Allowed	Allowed	Allowed	Not allowed	Not allowed

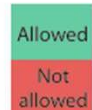

Alle ordrer fremstilles på dine specifikke mål i standard farve RAL 9005 struktur uden merpris og leveres normalt på ca 4-5 uger.

Andet farvevalg påregnes leveringstid på 5-6 uger. Andet farvevalg mod merpris.

3

Montering top og bundprofiler

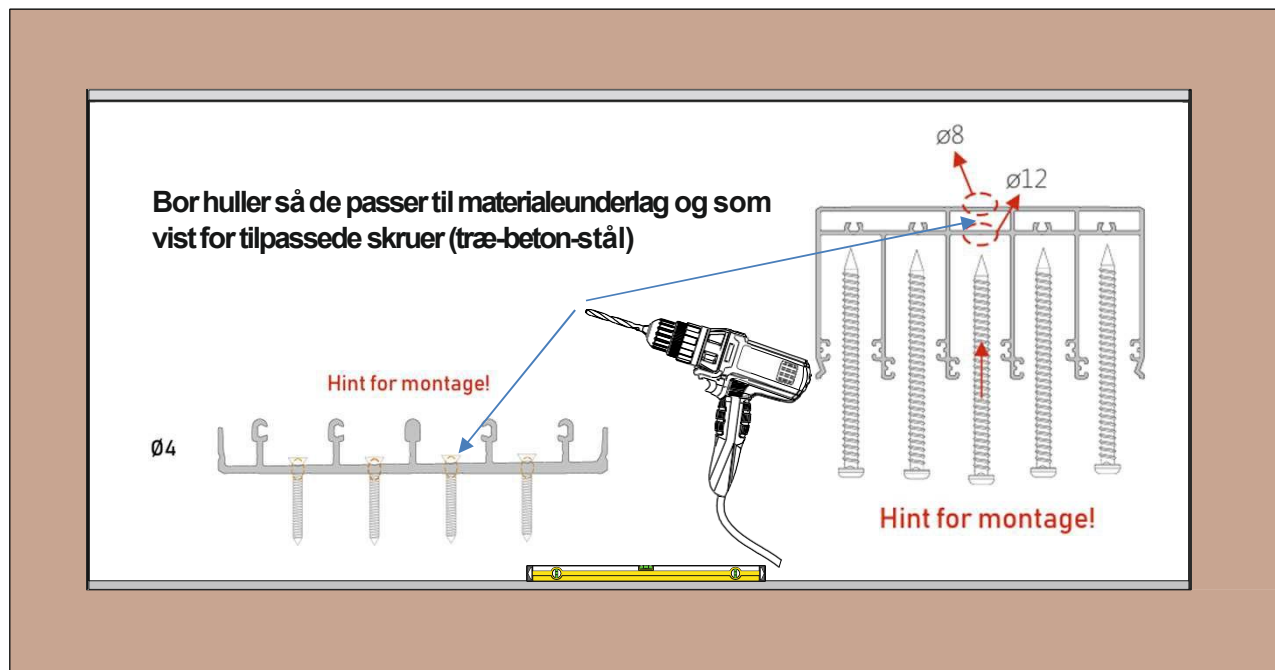

4

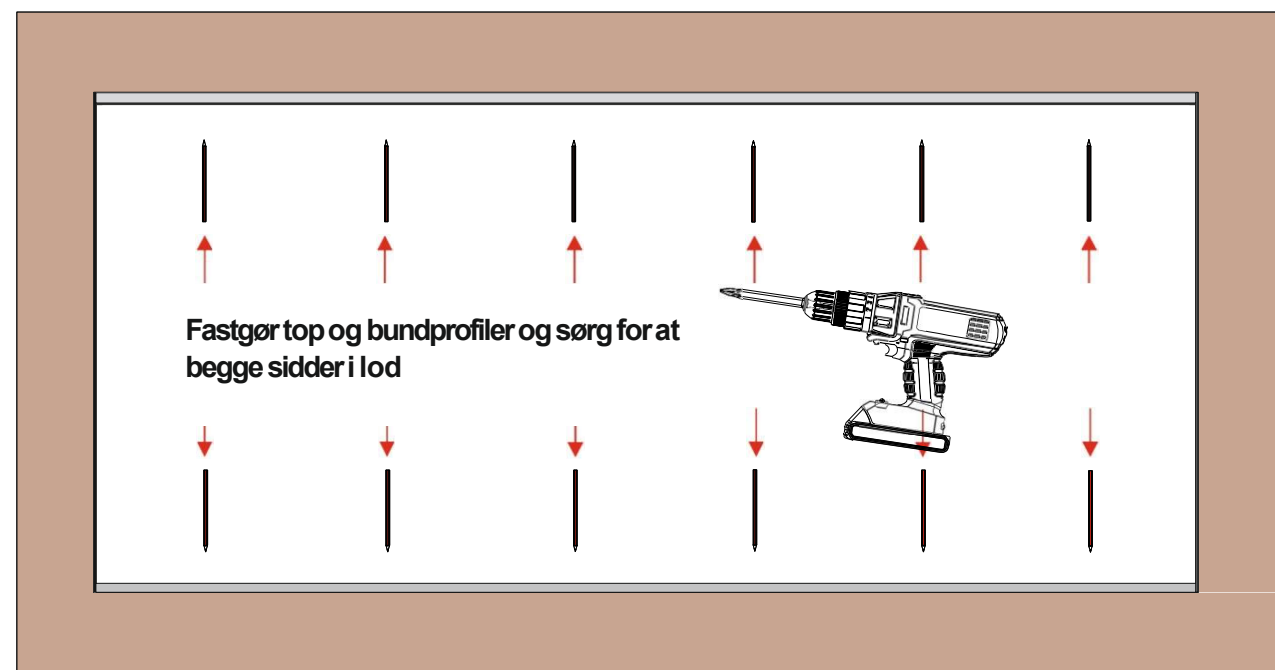

Montering af top og bundprofiler

5

Vigtigt: Bund og topskinner skal sidde vandrette og parallelle for at glas-skydedørene kører optimalt

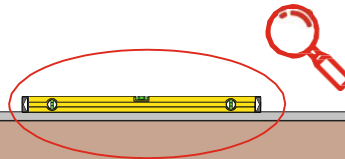
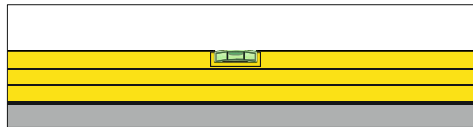

Brug oplødsning efter behov for opnå at profiler sidder vandret i lod

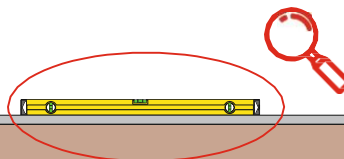
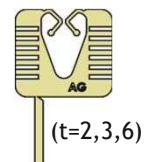
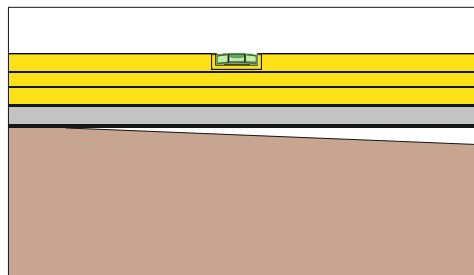

6

Tilpasning og montering af sideprofiler

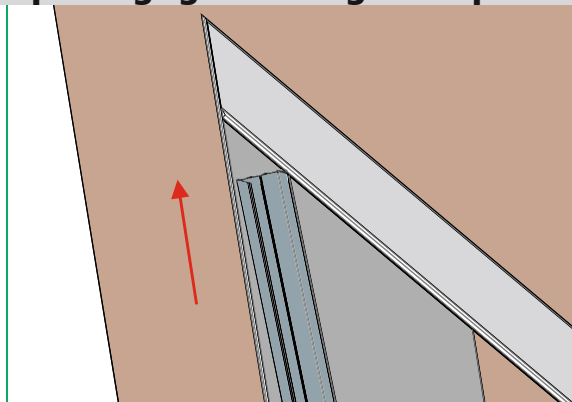

B1516001

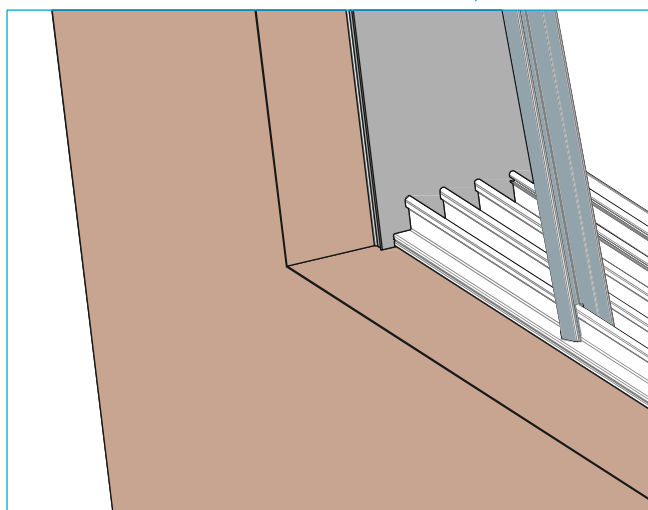
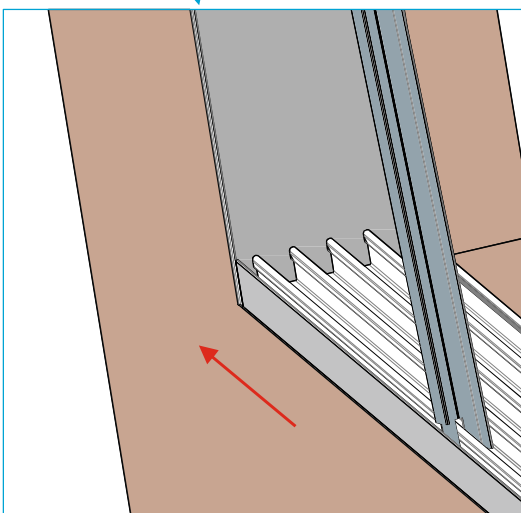
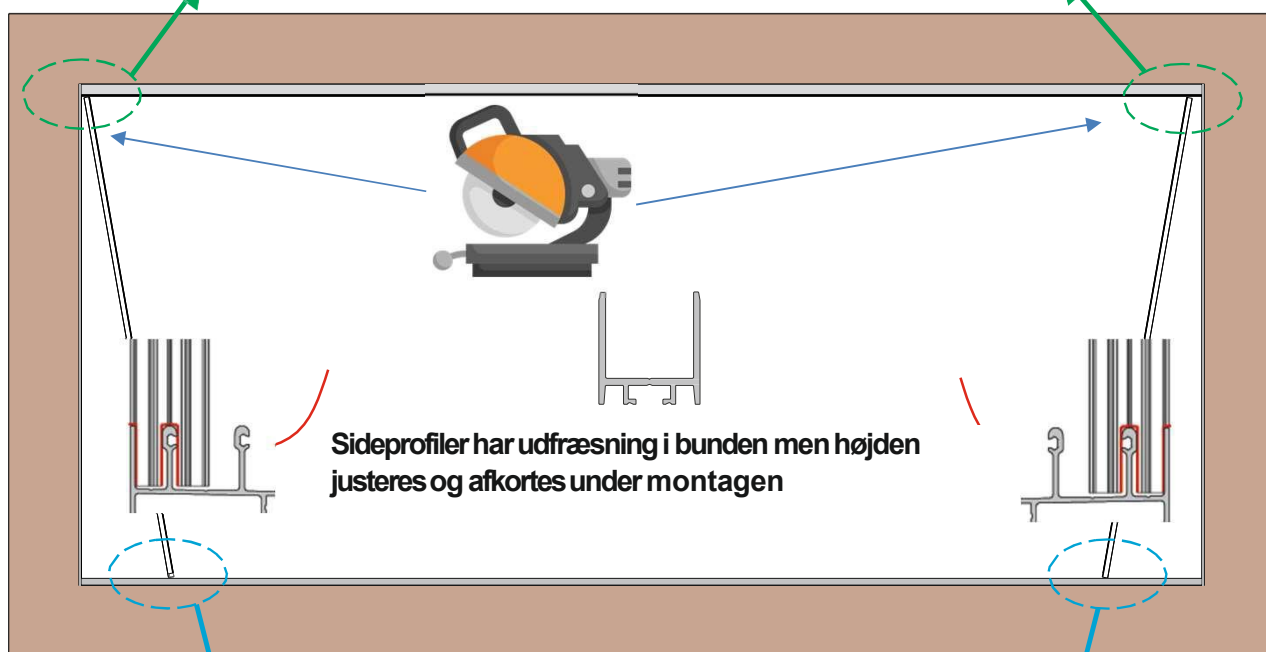
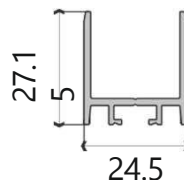

7

Tilpasning og montering af sideprofiler

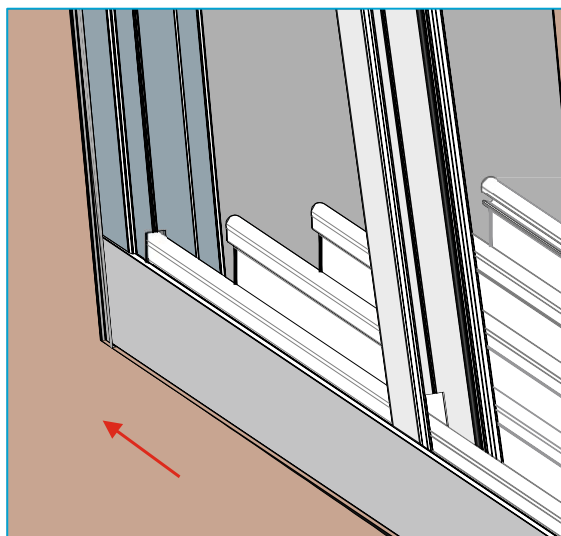
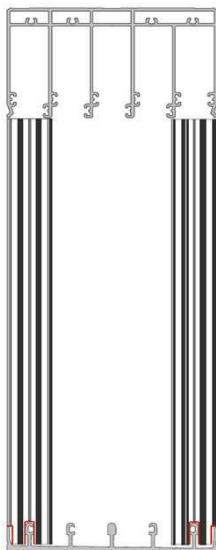
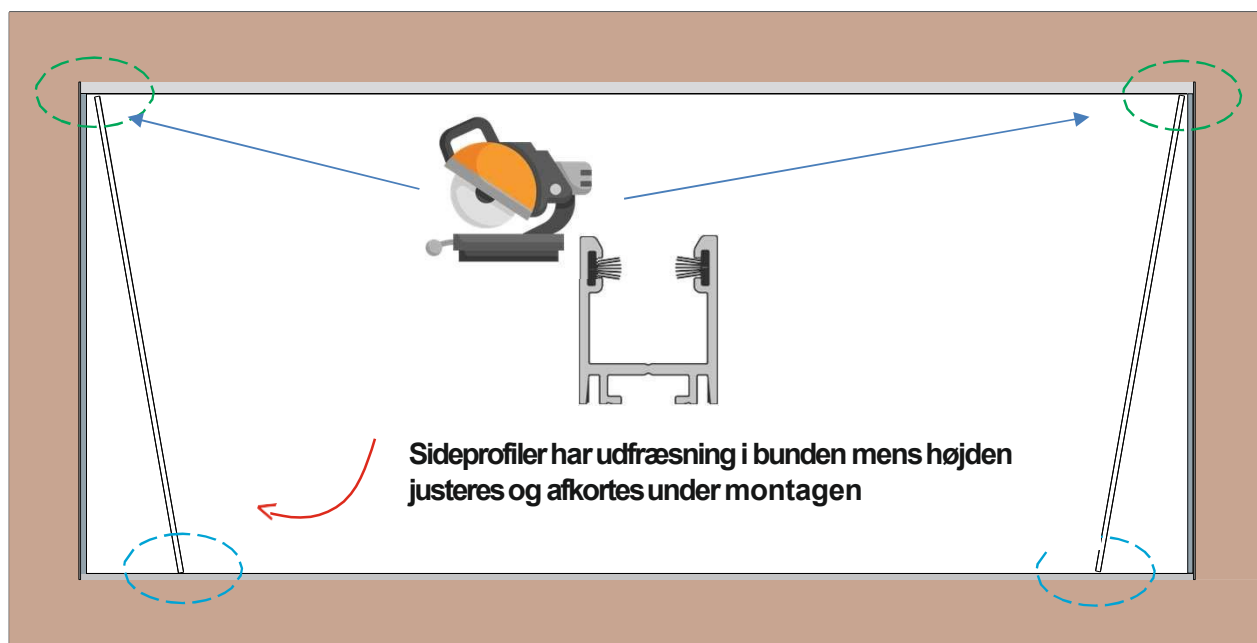
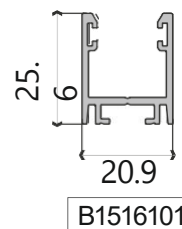
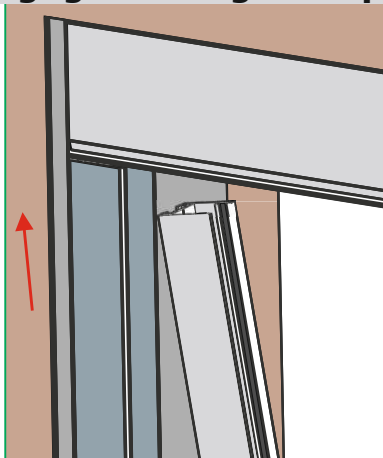

8

Tilpasning og montering af sideprofiler

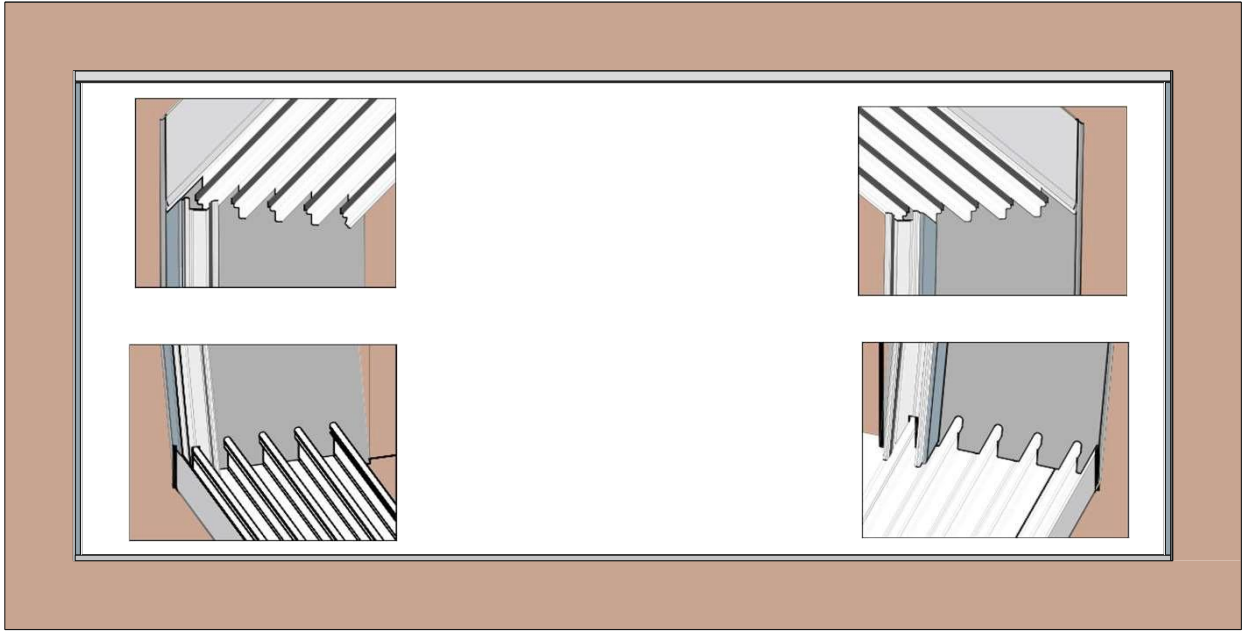

9

Montering af sidelister

25

B8503308

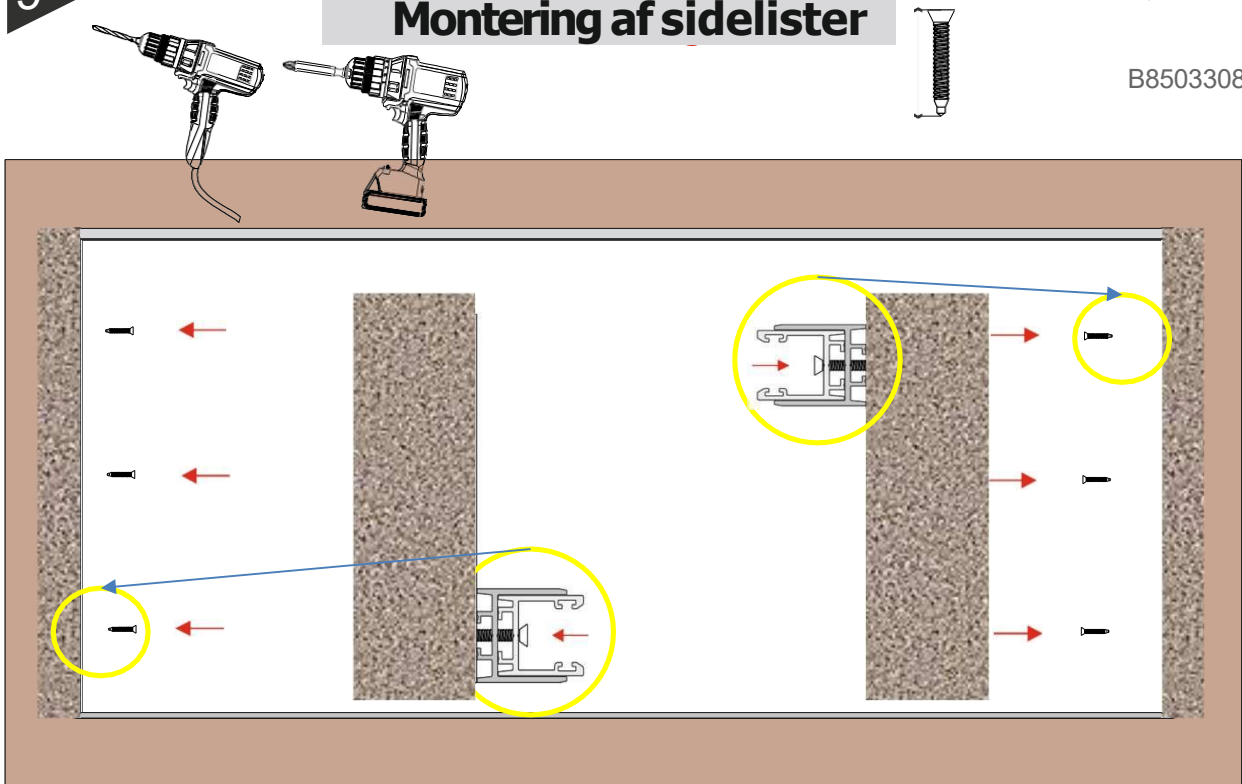

Montering af glas

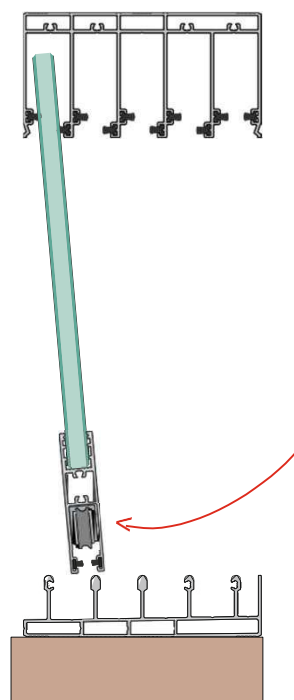
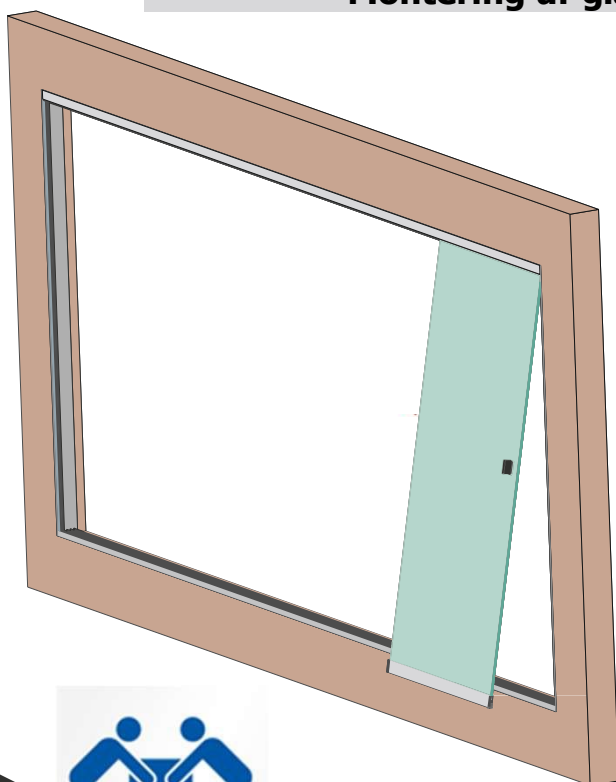

10



OBS. Der bør være 2 personer for håndtering af glas

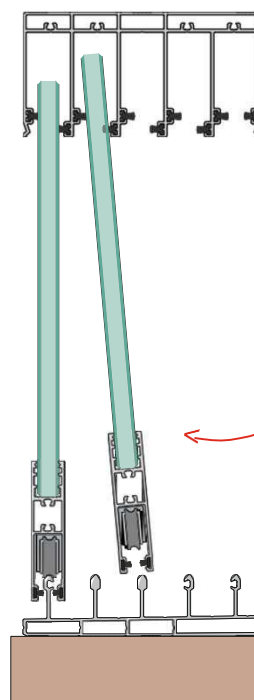
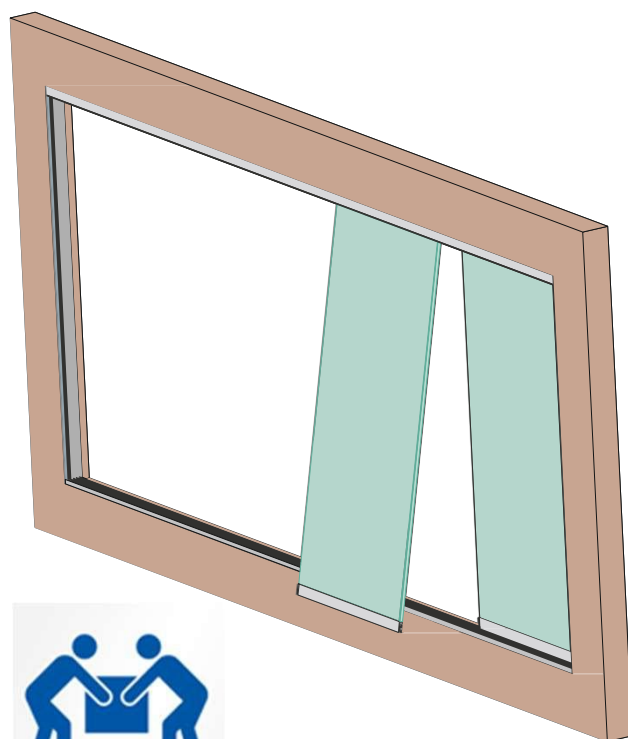

11



Montering af glas

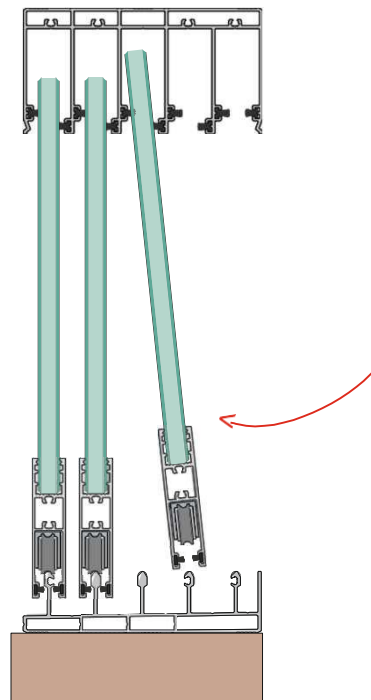
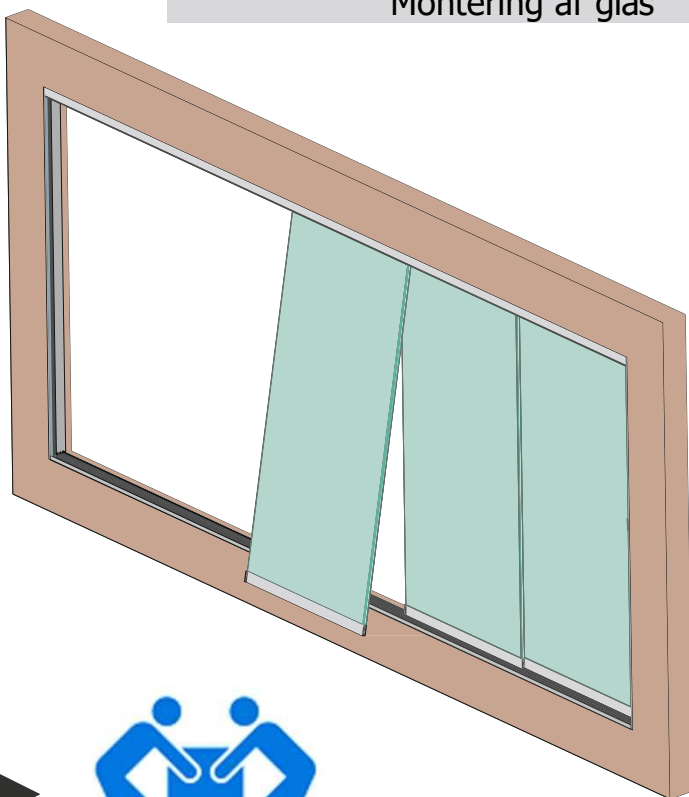

12



OBS. Der bør være 2 personer for håndtering af glas

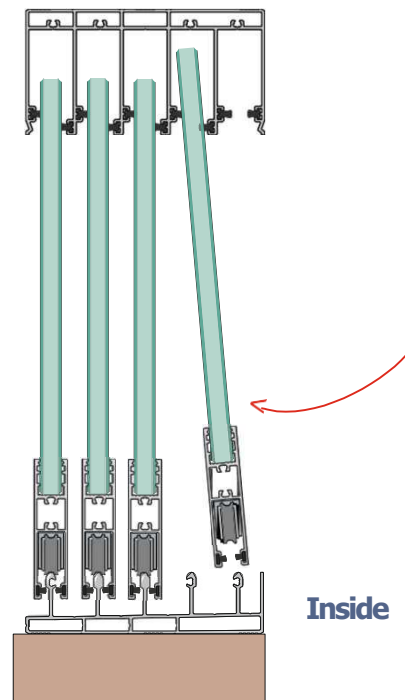
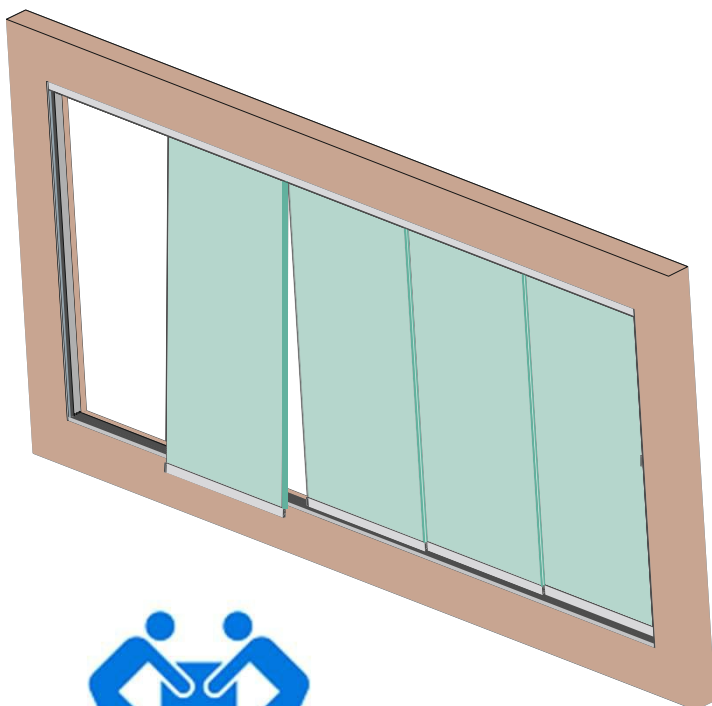

Montering af glas

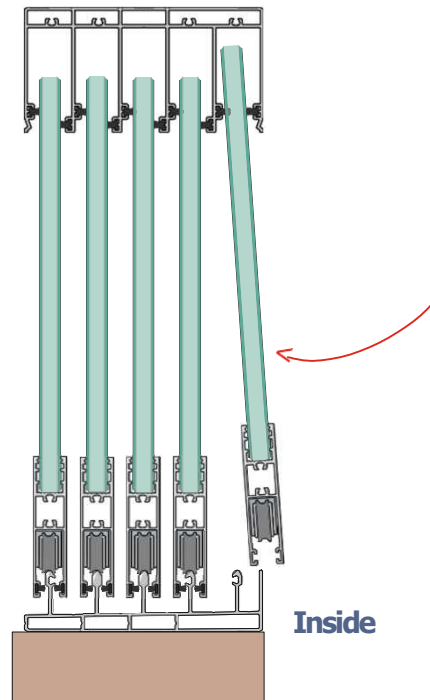
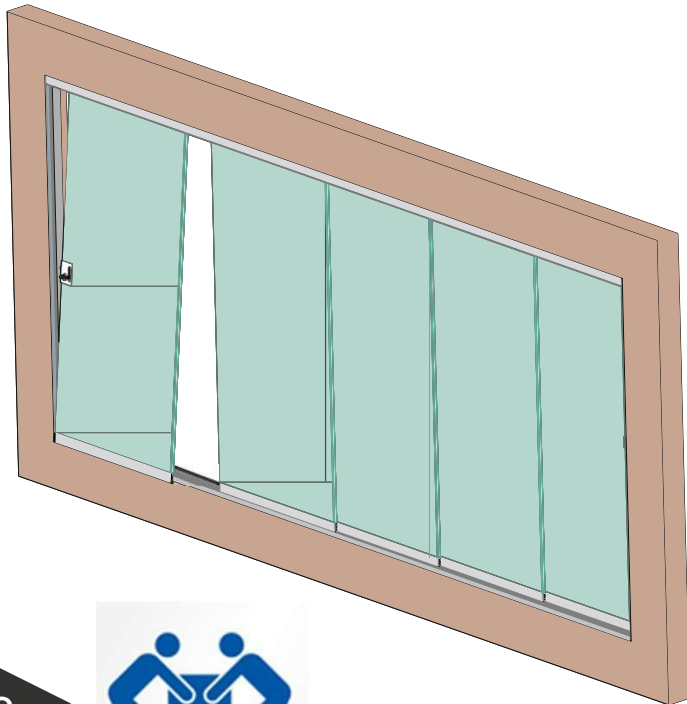

13

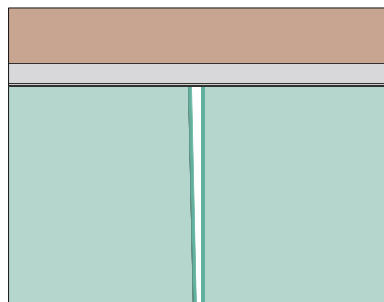

Check for glassalignment!

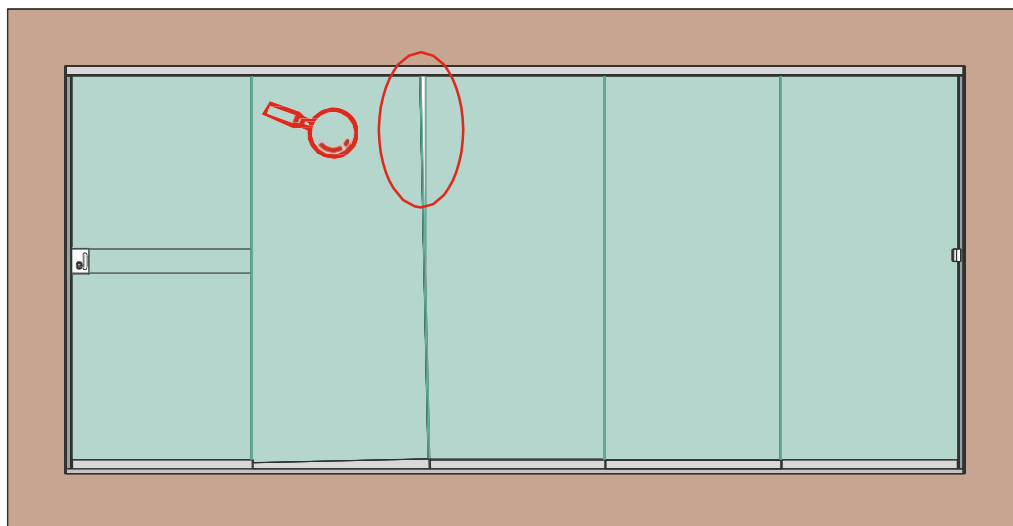

Montering af glas

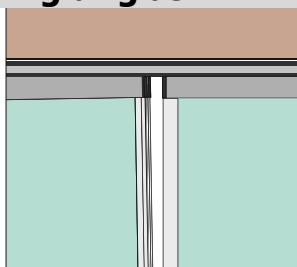

Check for glass alignment!

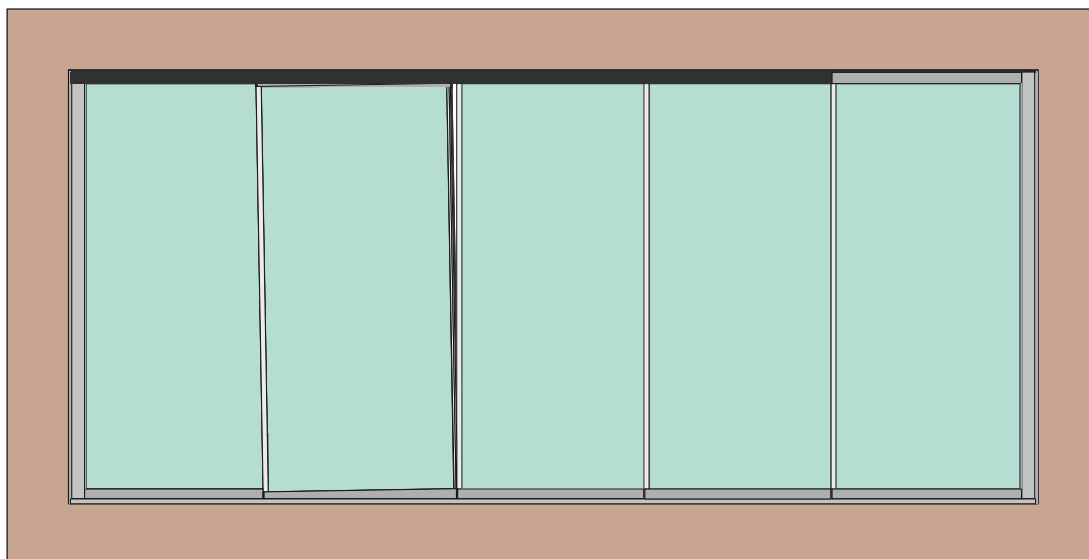

14

Justering

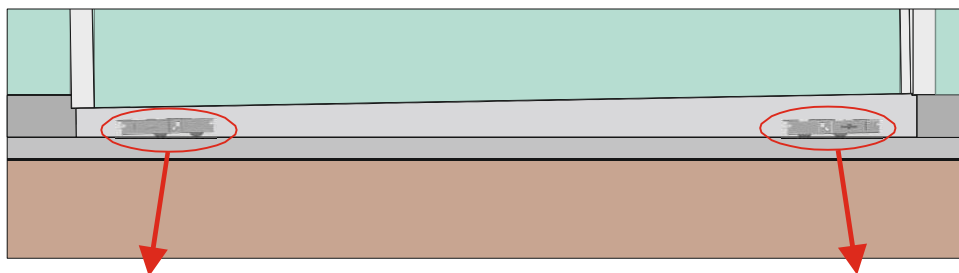

Justeringsmulighed i hjulbeslag 5mm op og ned

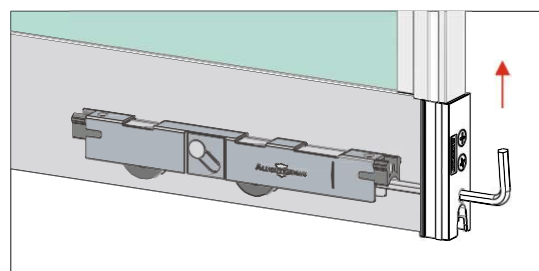
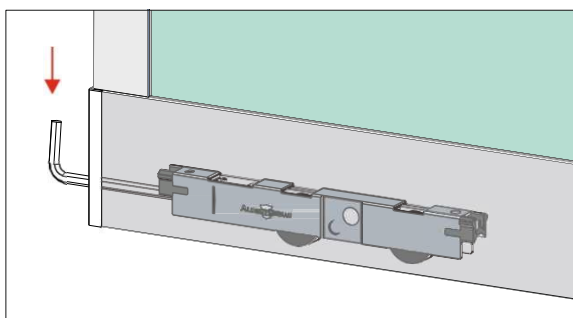

Udbytning af endebeslag venstre/ højre placering

15

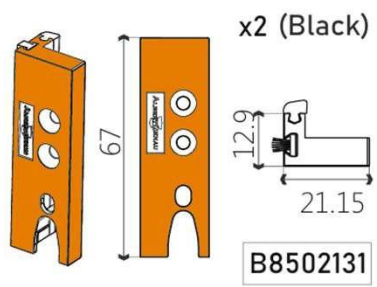
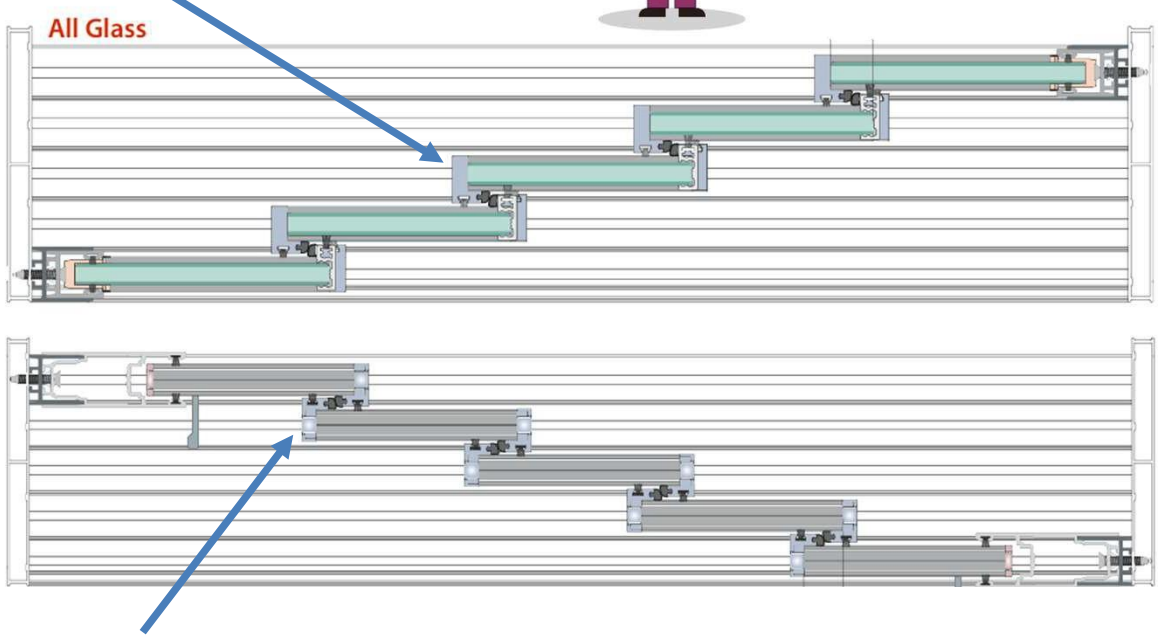
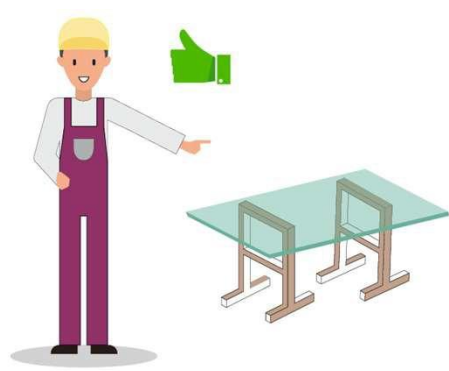
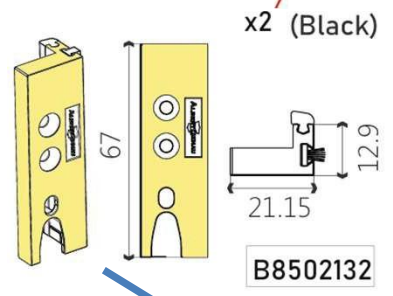
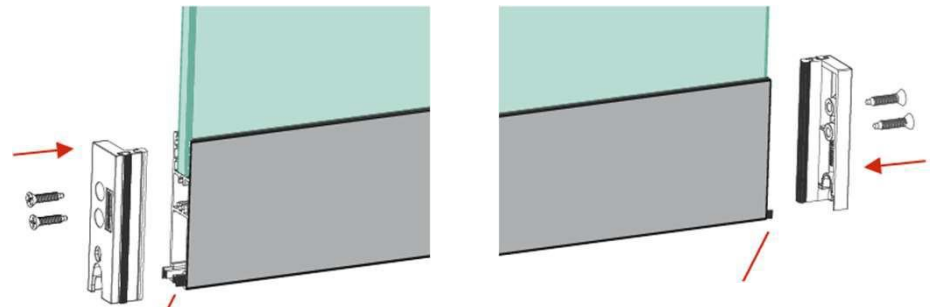

Ved at bytte medløber-endebe­slag på profilen der sid­der på glas kan ændres hvis glas­pane­lerne kører højre eller venstre i bundsporene.

Tætningslister mellem glas (tilvalg)

16

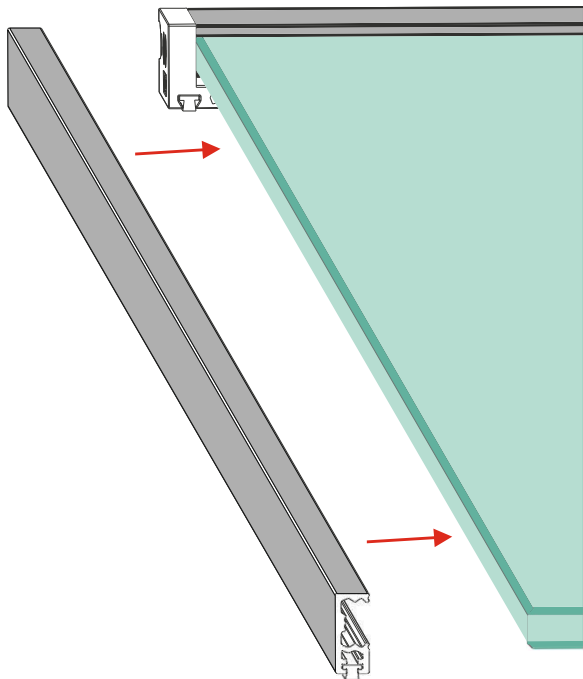

Brug polymer lim til
 montering af glasliste og brug
 ikke glasdørenei 32 timer

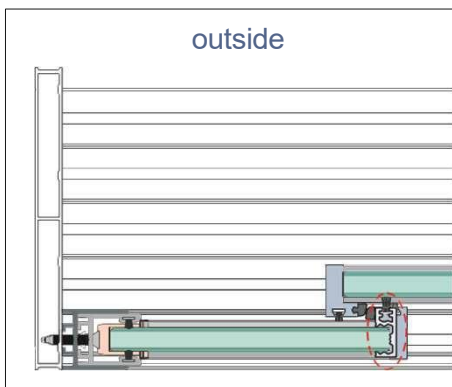
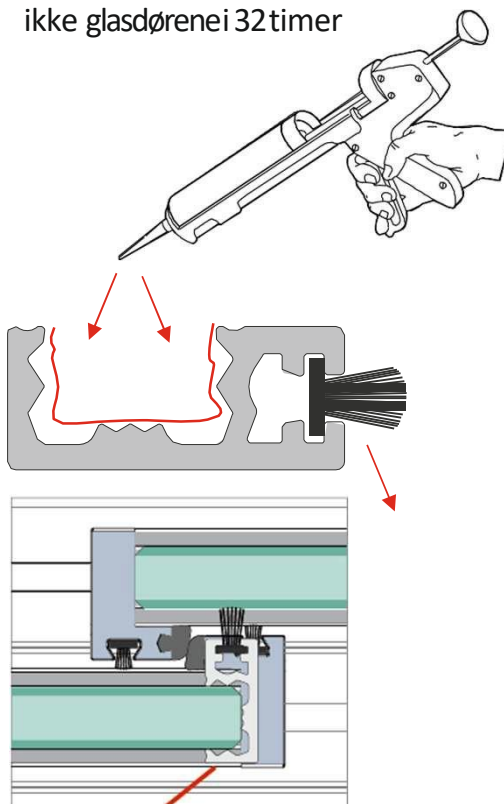

outside

Mellemliste til tætning i
 mellemglas (tilkøb) limes på
 glaskanten

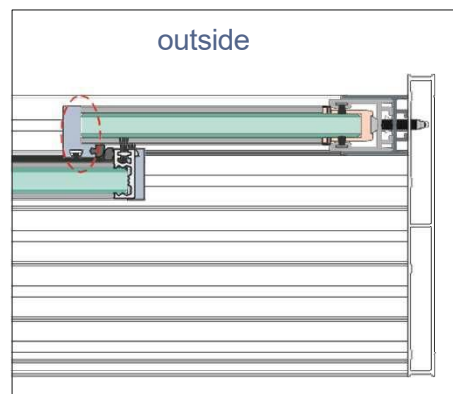

outside

outside



Slider Next Installation-All Glass System

Rundgreb selvklæbende

17



SliderNext - Smartlås



Smartlås

18

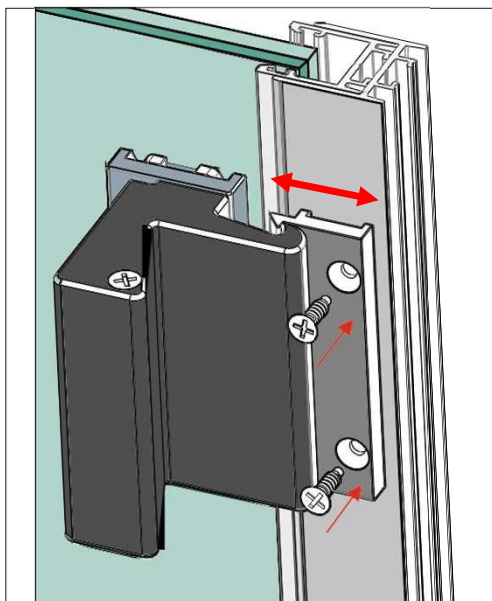

Montering af smartlås.

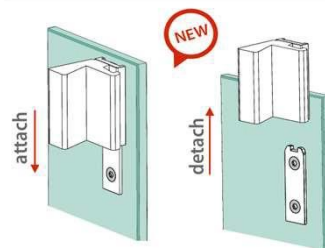
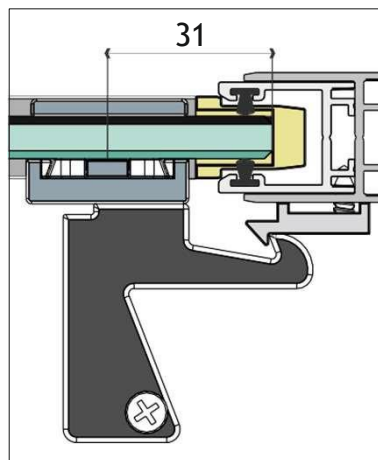

Nem rengøring

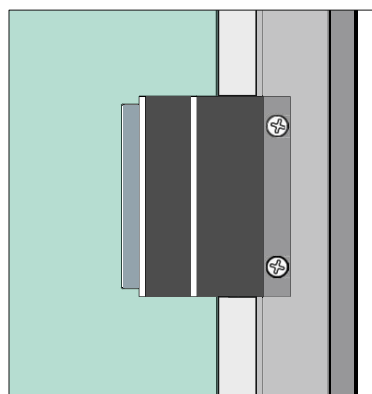
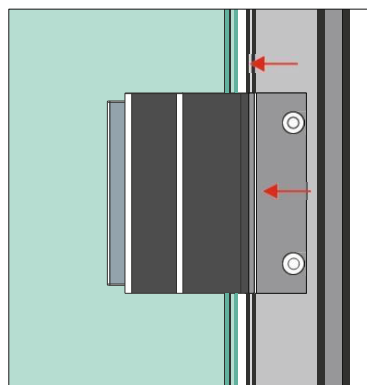
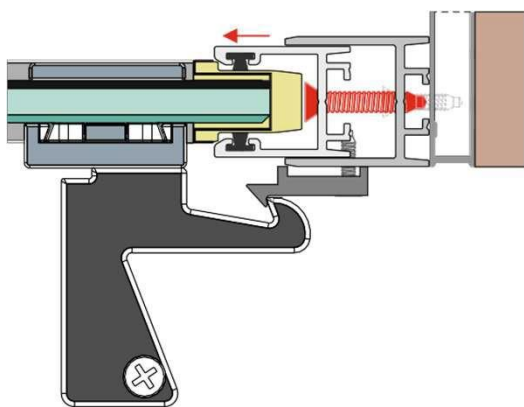
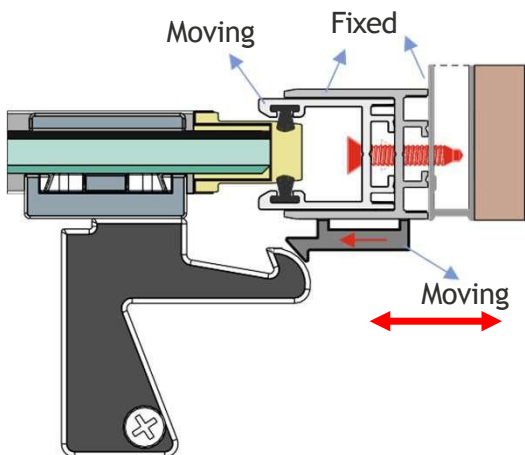

17

Fuge og rengøring

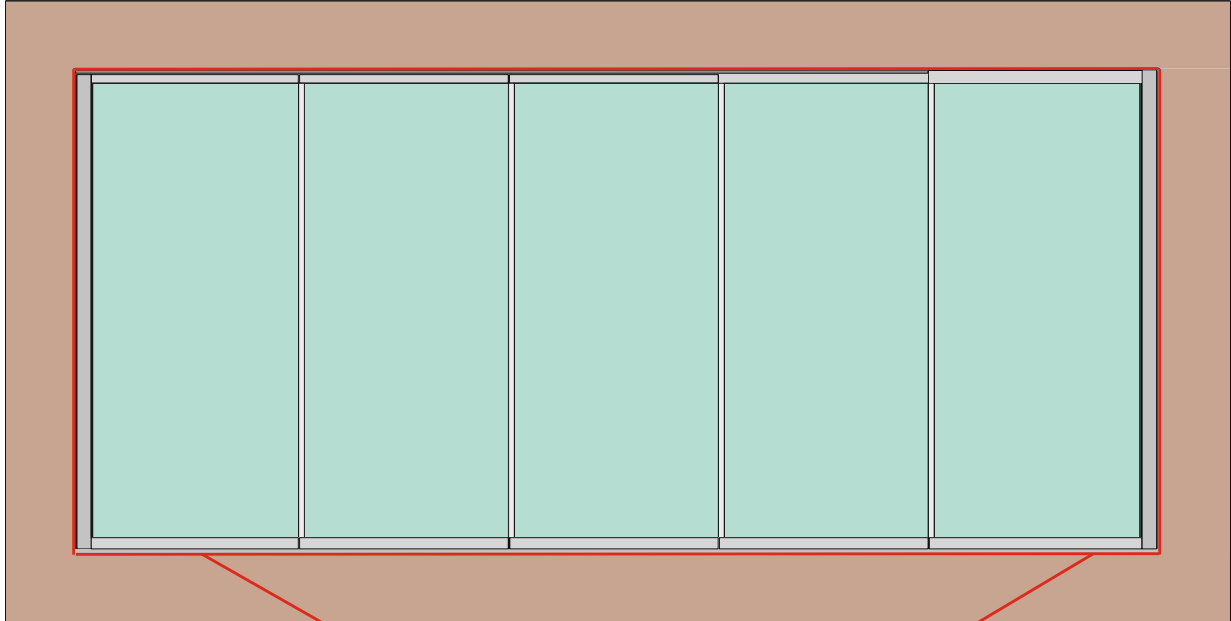

Luk ikke drænhuller med fuge!
Donot coverwaterdrainage holes with silicone!

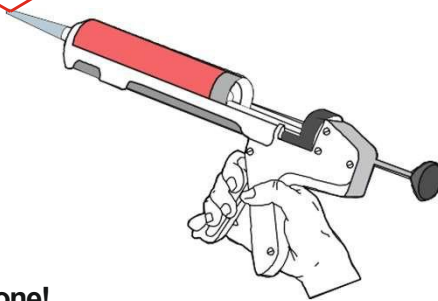

Vedligeholdelse:

Det anbefales, at glasskydedørene vedligeholdes og rengøres regelmæssigt.

Kontrollér løbende at alle skruesamlinger er spændt forsvarligt. Efterspænd dem om nødvendigt.

Sørg for at glaspanelerne er justeret i den helt rigtige højde. Anløbning af H-profilerne og medbringerne i bundskinnen kan medføre tidlig slitage. I bundskinnesystemet kan der samle sig snavs.

Sørg for at holde skinnen grundigt ren for at optimere produktets levetid.

Brug silikonespray for smøring. Snavsede aluminiumprofiler og glaspaneler kan rengøres med lunkent vand, blød klud, svamp og mild rengøringsmiddel som opvaskemiddel og glasrens.

Før produktet bruges første gang, skal glasskydedørene skylles grundigt med rent vand.

OBS. Brug aldrig skuremidler eller aggressive opløsningsmidler.

Brug aldrig højtryksrensere – brug ikke varmt vand.